

871



»» Features

- High rating Micro ISO automotive relays up to 35A/14VDC.
- SPNO & SPDT of contact configuration.
- Skirted cover and plain cover are both available.
- Optional to be equipped with diode or resistor.
- Comply with RoHS-Directive 2011/65/EU, and ELV-Directive 2000/53/EC.

»» Type List

Terminal style	Contact form	Designation (provided with)	Enclosure style			
			Dust cover	Dust cover /Fixed Base	Flux tight	Sealed type washable
Socket terminal	1A (SPNO)	-----	871-1A-D	871-1A-DF	871-1A-C	871-1A-S
		Resistor	871-1A-D-R1	871-1A-DF-R1	871-1A-C-R1	871-1A-S-R1
		Diode	871-1A-D-D1	871-1A-DF-D1	871-1A-C-D1	871-1A-S-D1
	1C (SPDT)	-----	871-1C-D	871-1C-DF	871-1C-C	871-1C-S
		Resistor	871-1C-D-R1	871-1C-DF-R1	871-1C-C-R1	871-1C-S-R1
		Diode	871-1C-D-D1	871-1C-DF-D1	871-1C-C-D1	871-1C-S-D1

»» Ordering Information

871 - 1A - C -
 1 2 3 4 5

1. 871 -- Basic series designation
2. 1A -- Single pole normally open
1C -- Single pole double throw
3. D -- Dust cover
DF -- Dust cover / base holder type available
C -- Flux tight
S -- Sealed type washable
4. Blank -- Standard type
R1 -- Coil parallel with 1/2W resistor for 6V 180Ω, 12V 680Ω, 24V 2700Ω
D1 -- Coil parallel with diode IN4007 the positive pole on # 85 terminal
5. -- Coil voltage (please refer to the coil rating data for the availability)

»» Contact Rating

Resistive load	1A	1C
	35A 14VDC 15A 28VDC	NO: 35A 14VDC , 15A 28VDC NC: 20A 14VDC , 10A 28VDC

»» Coil Rating (DC)

Rated voltage (V)	Rated current ±10 % at 23°C (mA)	Coil resistance ±10 % at 23°C (Ω)	Max. continuous voltage at 85°C	Pick up voltage(Max.) at 23°C	Drop out voltage(Min.) at 23°C	Power consumption at rated voltage
6	187.5	32	133 % of rated voltage	60 % of rated voltage	10 % of rated voltage	approx. 1.2W
12	97.5	123				
24	49.6	483				

>>> Specification

Contact material	AgSnO alloy	
Contact voltage drop ⁽¹⁾	Typ. 40mV at 10A	
Operate time ⁽¹⁾	10ms Max.	
Release time ⁽¹⁾	10ms Max.	
Insulation resistance ⁽¹⁾	20MΩ Min. (DC 500V)	
Dielectric strength ⁽¹⁾	Between open contact	: AC 500V , 50/60Hz 1 min.
	Between contact and coil	: AC 500V , 50/60Hz 1 min.
Vibration resistance	Operating extremes	10~500Hz , 5.0G
	Damage limits	10~500Hz , 5.0G
Shock resistance	Operating extremes	10G
	Damage limits	100G
Life expectancy	Mechanical	10,000,000 operations (frequency 18,000 operations/hr)
	Electrical	100,000 operations (frequency 1,800 operations/hr)
Temperature range	Operating	-40~+125°C (no freezing)
Weight	Approx. 20 g	

Note:(1)Initial value

>>> Outline Dimensions

◆871 (C,D)

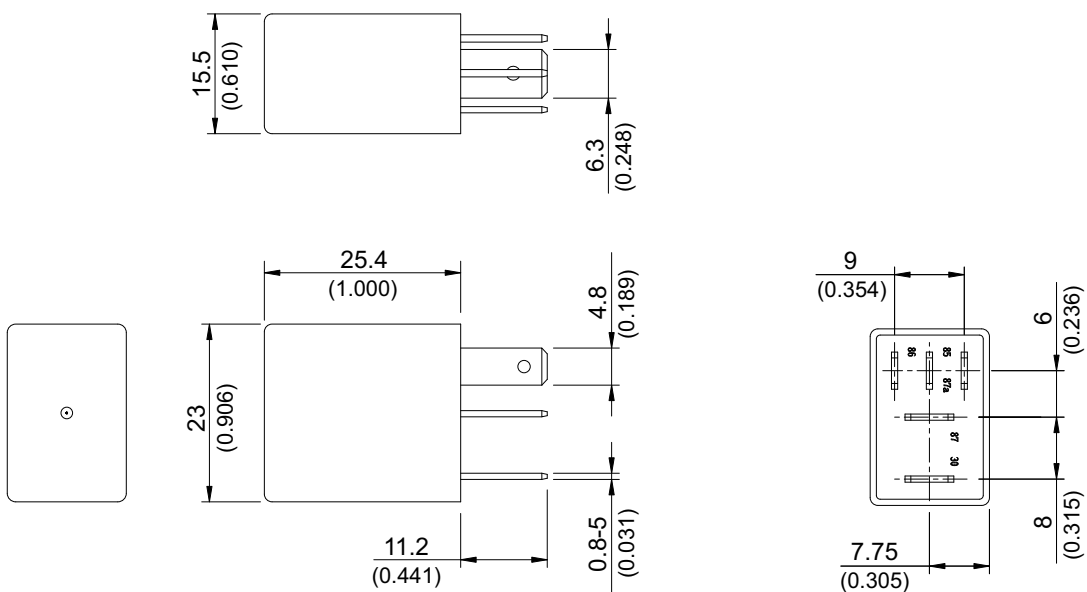

871

◆ 871 (DF)

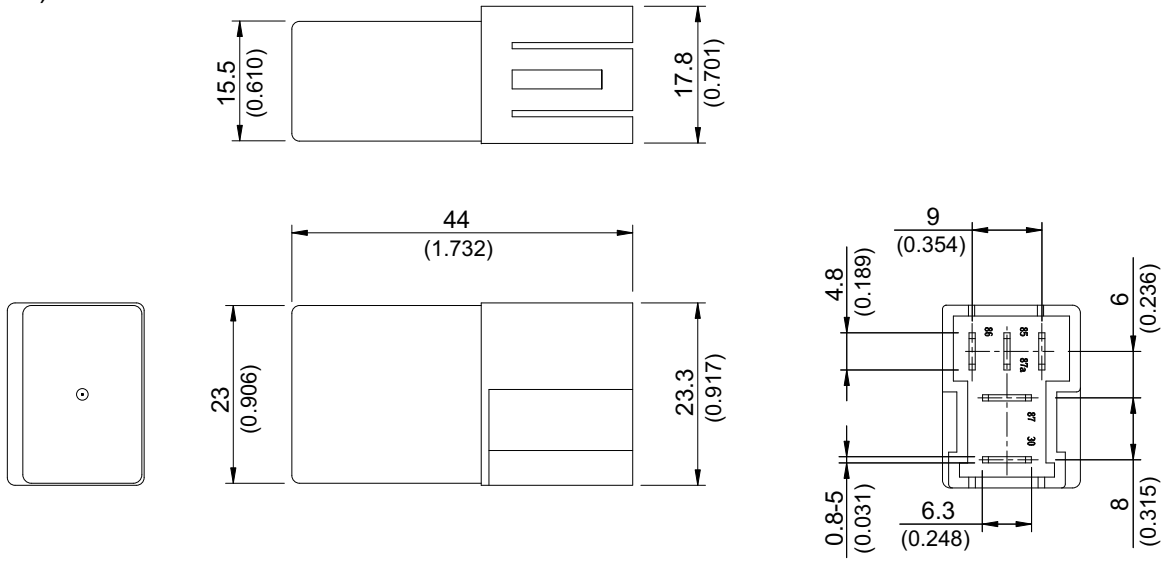

◆ 871 (S,V)

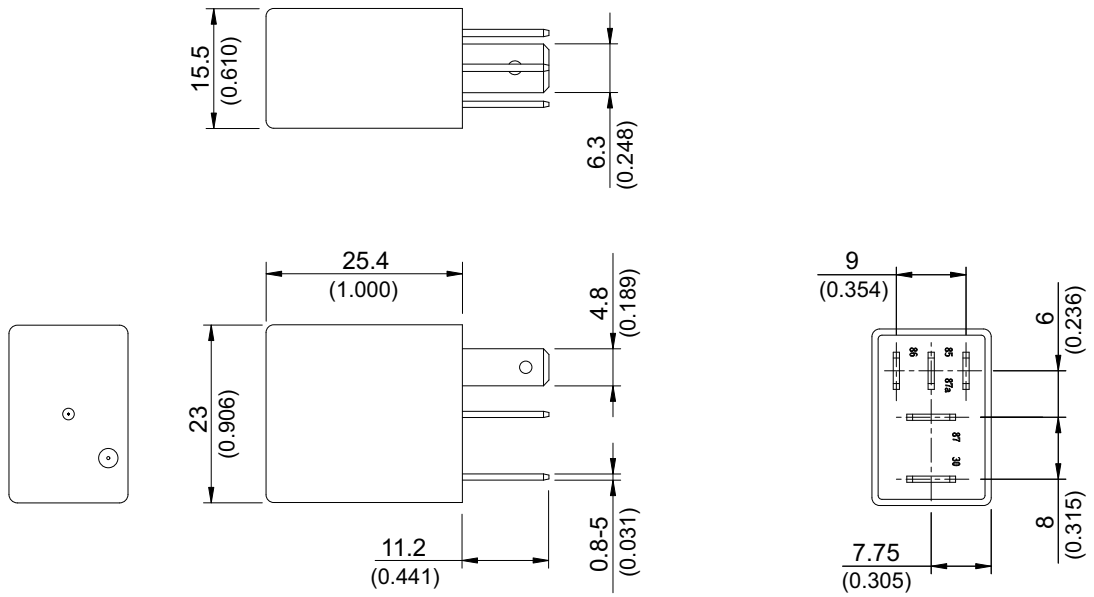

»» Wiring Diagram

BOTTOM VIEW

1C

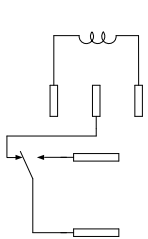

1A

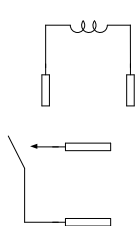

1C

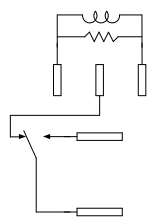

PROVIDED WITH RESISTOR

1A

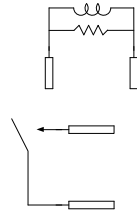

PROVIDED WITH RESISTOR

1C

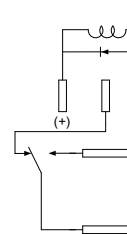

PROVIDED WITH DIODE

1A

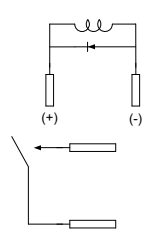

PROVIDED WITH DIODE

»» Engineering Data

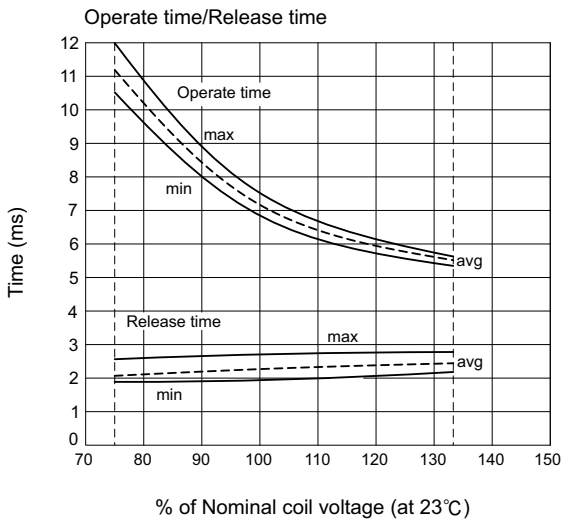
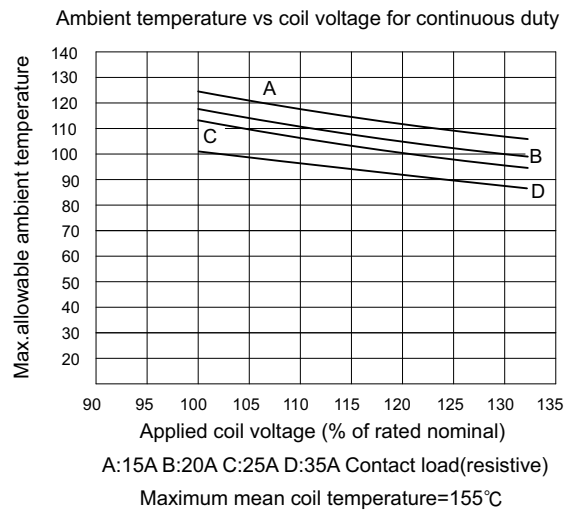
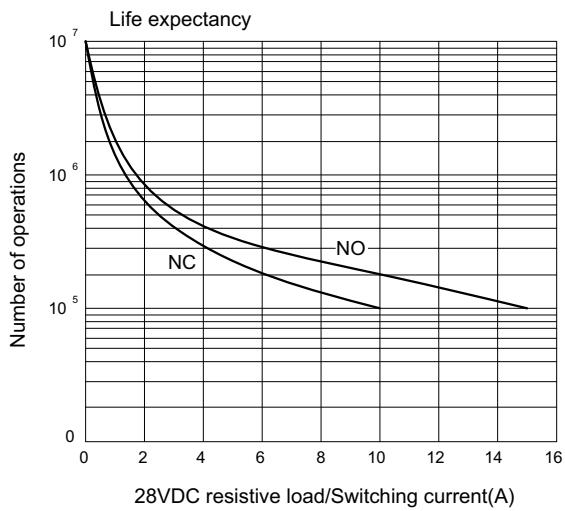
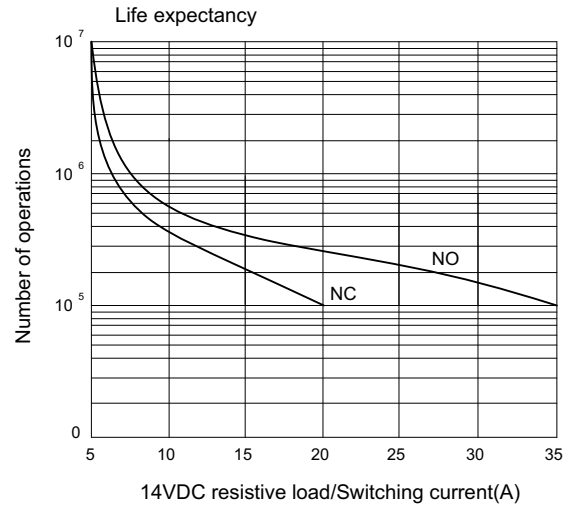
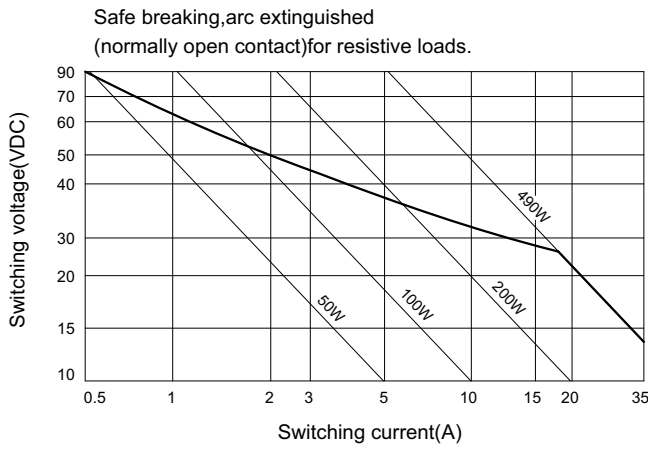

Mouser Electronics

Authorized Distributor

Click to View Pricing, Inventory, Delivery & Lifecycle Information:

[Song Chuan:](#)

[871-1C-S-D1-24VDC](#) [871-1A-S-24VDC](#) [871-1A-C-12VDC](#) [871-1C-C-R1-24VDC](#) [871-1C-S-D1-12VDC](#) [871-1A-S-12VDC](#) [871-1A-D-R1-12VDC](#) [871-1C-C-D1-12VDC](#) [871-1C-D-R1-24VDC](#) [871-1C-C-D1-24VDC](#)