

Features



- Ultra-fast 10 kHz switching frequency
- Red, green, and blue LEDs evaluated during TEACH to optimize application contrast, with the best color automatically selected by the sensor; sensing beam colors also may be individually disabled
- Outstanding color contrast sensitivity; detects 16 levels of gray scale
- Smart gain-control algorithm to maximize performance in low-contrast or high-gloss applications
- Easy-to-set, automatic *Expert*-style configuration options include Static and Dynamic TEACH, plus Manual Adjust for fine tuning
- Easy-to-read 8-segment bargraph display indicator for TEACH and signal strength readout, plus indicators for continuous readout of output status and setup
- Fixed-convergent sensing at 10 mm \pm 3 mm (0.39" \pm 0.12")
- Rectangular 1.2 mm x 3.8 mm (0.05" x 0.15") sensing image at 10 mm (0.39") from the lens
- Parallel or perpendicular sensing image, depending on model (see below)
- Rugged zinc alloy die-cast housing with high-quality acrylic lens suitable for food processing applications; rated IP67, NEMA 6
- Easy selection of Light/Dark Operate (LO/DO), 30 ms pulse stretcher (OFF-delay), and 30 ms ON-delay, via push buttons or a remote input wire

Models

Models	Cable*	Focus	Supply Voltage	Output Type	Sensing Image Orientation
R58ECRGB1	5-wire 2 m (6.5')	10 mm (0.39")	10 to 30V dc	Bipolar NPN/PNP	
R58ECRGB1Q8	5-pin Euro-style integral QD				
R58ECRGB1Q	5-pin Euro-style QD pigtail				
R58ECRGB2	5-wire 2 m (6.5')				
R58ECRGB2Q8	5-pin Euro-style integral QD				
R58ECRGB2Q	5-pin Euro-style QD pigtail				

* 9 m cables are available by adding suffix "W/30" to the model number of any cabled sensor (e.g., R58ECRGB1 W/30).
A model with a QD connector requires a mating cable; see page 10.



WARNING . . . Not To Be Used for Personnel Protection

Never use these products as sensing devices for personnel protection. Doing so could lead to serious injury or death.

These sensors do NOT include the self-checking redundant circuitry necessary to allow their use in personnel safety applications. A sensor failure or malfunction can cause either an energized or de-energized sensor output condition. Consult your current Banner Safety Products catalog for safety products which meet OSHA, ANSI and IEC standards for personnel protection.

R58 Expert™ Registration Mark Sensors

Overview

R58 Expert (R58E) sensors offer maintenance-free solid-state reliability for typical color contrasts found in product and material registration applications. Fast 50-microsecond sensing response produces excellent registration repeatability, even in ultra-high-speed applications. This fast response, coupled with the small 1.2 x 3.8 mm (0.05" x 0.15") sensing image, allows the detection of even small and inconspicuous registration marks.

R58E sensors feature TEACH mode sensitivity adjustment by presenting two sensing conditions to the sensor. TEACH mode has two options: Static TEACH and Dynamic TEACH. Static TEACH is used to position the two sensing conditions individually. Dynamic TEACH provides a means for teaching a series of conditions on-the-fly; the R58E samples the sensing events and automatically sets the switchpoint between the lightest and darkest conditions. The sensor then determines which sensing condition is present for the shortest time and assigns the Output ON condition to that event (therefore, LO/DO selection is automatic). The LO/DO setting can then be reversed in SETUP mode.

The sensor uses a tri-color LED during either teach process and automatically selects a red, green, or blue sensing beam, based on the contrast between the registration mark and its background. For applications where the user wishes to select the sensing beam color, individual colors may be enabled/disabled in SETUP mode.

Sensitivity may be fine-tuned at any time by simply clicking the "+" or "-" buttons on the sensor. The eight-element bargraph display clearly displays the relative received signal strength.

The discrete bipolar (one NPN and one PNP) outputs may be configured in SETUP mode to include a 30-millisecond ON-delay and/or OFF-delay, if required.

TEACH and SETUP configuration may be accomplished either by using the push button on the sensor, or by supplying input pulses via the remote TEACH input. The push buttons may be disabled via the remote input.

The construction of the R58E is extremely robust, with a die-cast metal housing, plastic optics, and IP67 and NEMA 6 leakproof design for harsh sensing environments.

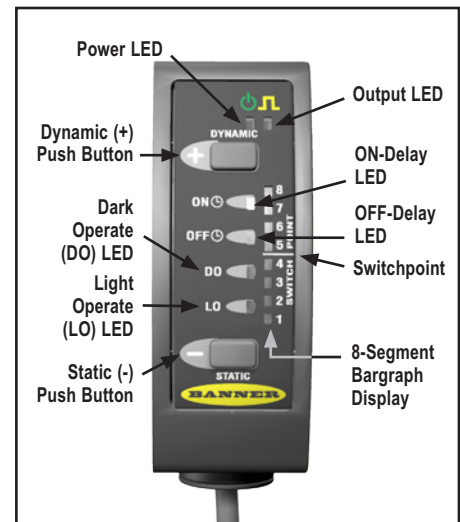

Figure 1. Sensor features

R58 Expert™ Registration Mark Sensors

Sensor Configuration

The R58E is pre-set to power up in RUN mode and sense the most recently taught registration mark. The sensitivity of the R58E may be quickly optimized by using one of two available TEACH modes: Static TEACH or Dynamic TEACH.

- **Static TEACH:** Both the Output ON and Output OFF conditions are presented, and sensitivity can be adjusted manually via the push buttons.
- **Dynamic TEACH:** The registration mark is presented during actual sensing conditions, and the sensitivity can be adjusted manually via the push buttons.

Remote TEACH

The sensor may be configured either via its push buttons, or via a remote switch. Remote configuration also may be used to enter SETUP mode to set ON- and OFF-delay, and to disable the push buttons to prevent unauthorized adjustment of the configuration settings. To access this feature, connect the gray wire of the sensor to 0V dc, with a remote switch between the sensor and 0V dc.

Configuration is accomplished by following the sequence of input pulses (see following procedures). The duration of each pulse (corresponding to a push button “click”), and the period between multiple pulses, are defined as “T”:

$$0.04 \text{ seconds} \leq \text{“T”} \leq 0.8 \text{ seconds}$$

Status Indicators

LED	Indicates
Power	ON Green: RUN mode OFF: TEACH or SETUP mode
Output	ON Yellow: Output is conducting, or TEACH Output ON condition OFF: Output is not conducting, or TEACH Output OFF condition
Light Operate	ON Green: Light Operate (LO) operation
Dark Operate	ON Green: Dark Operate (DO) operation
OFF-Delay	ON Green: 30 ms pulse stretcher (OFF-delay) is active OFF: No OFF-delay
ON-Delay	ON Green: 30 ms ON-delay is active OFF: No ON-delay
8-Segment Bargraph Display	ON Red: RUN mode — Indicates signal strength with respect to the sensing threshold (switchpoint); higher segment number for higher sensing contrast TEACH mode — Indicates relative contrast SETUP mode — Displays sensing beam LED color (see Figure 5) OFF: TEACH or SETUP mode — Sensor configuration active

R58 Expert™ Registration Mark Sensors

Static TEACH

In Static TEACH mode, the sensor learns two sensing conditions after each is presented one time. The sensor automatically positions the switchpoint midway between the two conditions. See Figure 3.

NOTE: The sensor will return to RUN mode if either TEACH condition is not registered within 60 seconds. TEACH mode may be cancelled by pressing and holding the Static push button for ≥ 2 seconds. In either case, the sensor will revert to the previous conditions taught (i.e., exit without save).

Static TEACH and Manual Adjust

Sensitivity may be adjusted at any time when the sensor is in RUN mode by clicking the “+” and “-” buttons. Each click translates to 1/2 segment on the signal strength bargraph display. For best sensing reliability, both sensing conditions should register equally distant from the switchpoint on the signal strength bargraph display.

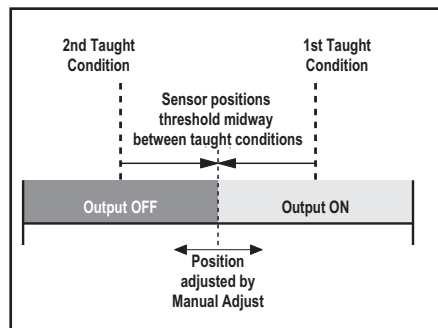

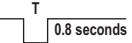



Figure 2. Static TEACH (Light Operate shown)

	Procedure		Result
	Push Button 0.04 sec. \leq “click” \leq 0.8 sec.	Remote Line 0.04 sec. \leq “T” \leq 0.8 sec.	
Access TEACH Mode	<ul style="list-style-type: none"> Push and hold the Static push button for > 2 seconds. 	<ul style="list-style-type: none"> No action required; sensor is ready for the 1st sensing condition. 	<p>(push button only)</p> <ul style="list-style-type: none"> LO and DO: Alternately flash Green Output: ON Yellow (indicating ready to teach 1st sensing condition) Bargraph display: Goes OFF
Teach 1st Sensing Condition	<ul style="list-style-type: none"> Present the 1st sensing condition. “Click” the Static push button. 	<ul style="list-style-type: none"> Present the 1st sensing condition. Single-pulse the remote line. Wait at least 0.8 seconds. 	<ul style="list-style-type: none"> LO and DO: Alternately flash Green Output: OFF (indicating ready to teach 2nd sensing condition) Bargraph display: Remains OFF
Teach 2nd Sensing Condition	<ul style="list-style-type: none"> Present the 2nd sensing condition. “Click” the Static push button. 	<ul style="list-style-type: none"> Present the 2nd sensing condition. Single-pulse the remote line. 	<p>Teach Accepted</p> <ul style="list-style-type: none"> Bargraph display flashes one segment for three seconds to indicate relative contrast (see contrast table on page 5). Sensor enters RUN mode.
			<p>Teach Unacceptable</p> <ul style="list-style-type: none"> Pairs of bargraph display segments flash for three seconds to indicate low contrast. Sensor returns to TEACH 1st sensing condition.

R58 Expert™ Registration Mark Sensors

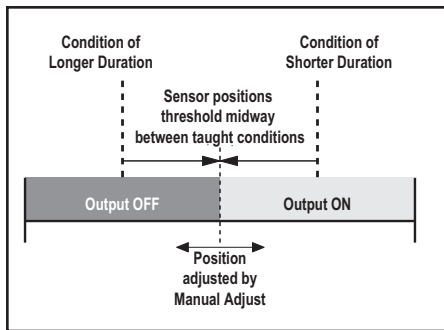

Figure 3. Dynamic TEACH (Light or Dark Operate, depending on the sensing condition shown)

Bargraph Display Segment*	Relative Contrast / Recommendation
6 to 8	Excellent: Very stable operation.
4 to 5	Good: Minor sensing variables will not affect sensing reliability.
2 to 3	Low: Minor sensing variables may affect sensing reliability.
1	Poor: Consider an alternate sensing scheme.

*Following TEACH

NOTE: High contrast relates directly to sensing reliability; high-contrast sensing applications are most tolerant of sensing variables (e.g., web flutter or variations in registration mark color and print density).

Dynamic TEACH

Dynamic TEACH is used to configure sensitivity during actual sensing conditions, when looking for a mark against its background condition. The R58E takes multiple samples of the registration mark against its background material and automatically positions the threshold at the optimum level. See Figure 2. *The registration mark must be presented at least two times during Dynamic TEACH.*

When Dynamic TEACH is used, the Output ON state will be the shorter duration (smaller) event sensed, and LO/DO will be set accordingly. To change the output state, change to either LO or DO in SETUP mode, or pulse the remote line three times (see page 8).

Maximum Feed Rate

In order to optimize performance and ensure that all LED color and gain combinations are evaluated during Dynamic TEACH, the registration mark must encompass the 1.2 mm dimension of the 1.2 mm x 3.8 mm sensing image for at least 0.002 seconds. Therefore, the maximum feed rate can be determined with the following formula:

$$\text{Maximum Feed Rate in mm/sec.} = (\text{registration mark width in mm} - 1.2) / 0.002$$

Example with a 5 mm registration mark:

$$\text{Maximum Feed Rate} = (5 \text{ mm} - 1.2) / 0.002 = 1900 \text{ mm/sec.}$$

NOTE: Registration marks narrower than the 1.2 mm sensing image width can be detected at feed rates less than 600 mm/sec, but the contrast will be reduced, due to averaging of the background and the registration mark.

Dynamic TEACH and Manual Adjust

Sensitivity may be adjusted at any time when the sensor is in RUN mode by clicking the “+” and “-” buttons. Each click translates to 1/2 segment on the bargraph display. For best sensing reliability, the light and dark conditions should register equally distant from the switchpoint on the bargraph display.

	Procedure		Result
	Push Button	Remote Line	
Access TEACH Mode	<ul style="list-style-type: none"> Press and hold the Dynamic push button for > 2 seconds. 	<ul style="list-style-type: none"> Hold the remote line low for > 2 seconds. 	LO and DO: Alternately flash Green Output: OFF Bargraph display: Goes OFF
Teach Sensing Conditions	<ul style="list-style-type: none"> Continue to hold Dynamic push button. Present sensing conditions (present registration mark at least twice). 	<ul style="list-style-type: none"> Continue to hold the remote line low. Present sensing conditions (present registration mark at least twice). 	LO and DO: Alternately flash Green Output: OFF Bargraph display: Remains OFF
Return to RUN Mode	<ul style="list-style-type: none"> Release the Dynamic push button. 	<ul style="list-style-type: none"> Release remote line/switch. 	<p style="text-align: center;">Teach Accepted</p> <ul style="list-style-type: none"> Bargraph display flashes one segment for three seconds to indicate relative contrast (see contrast table above). Sensor enters RUN mode.
			<p style="text-align: center;">Teach Unacceptable</p> <ul style="list-style-type: none"> Pairs of bargraph display segments flash in unison for three seconds to warn of unacceptably low contrast. Sensor returns to RUN mode without changing settings.

R58 Expert™ Registration Mark Sensors

SETUP Mode

SETUP mode is used to configure discrete sensor output response for:

- Light or Dark Operate
- 30-millisecond pulse stretcher (OFF-delay), if required
- 30-millisecond ON-delay, if required.

It is also used to disable one or more sensing beam colors, to force the sensor to use a particular color. It will be necessary to access SETUP mode only if the settings which result from TEACH mode configuration are not the settings required for the application or if a delay is required. The status LEDs indicate the output response configuration when the sensor is in RUN mode, as shown in Figure 4.

Change the output response settings or disable sensing beam color(s) as shown in the table on page 7.

NOTE: If SETUP mode programming is interrupted and remains inactive for 60 seconds, the sensor returns to RUN mode with the most recent settings (i.e., exits and saves current selection).

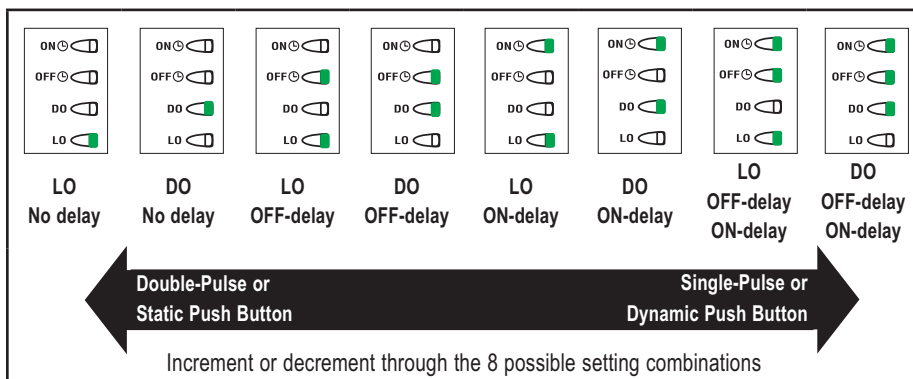

Figure 4. Output response configuration options

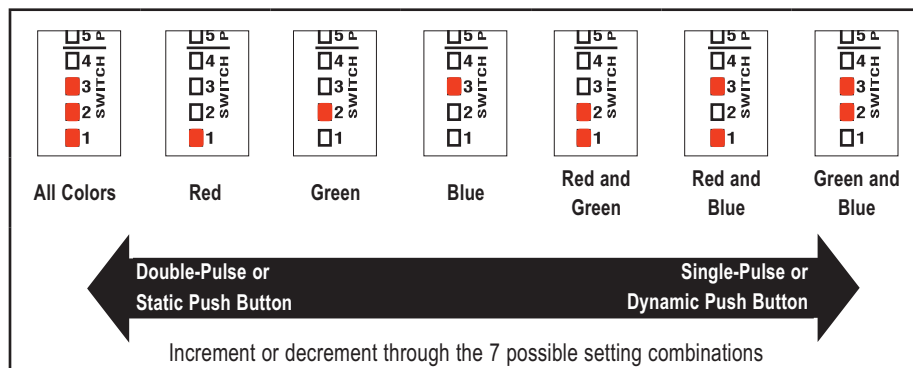



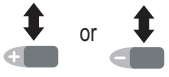
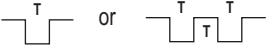



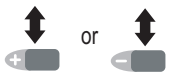
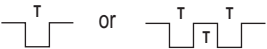



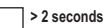

Figure 5. LED color configuration options

R58 Expert™ Registration Mark Sensors

SETUP Configuration

	Procedure		Result
	Push Button 0.04 sec. ≤ "click" ≤ 0.8 sec.	Remote Line 0.04 sec. ≤ "T" ≤ 0.8 sec.	
Enter SETUP Mode	<ul style="list-style-type: none"> Press and hold both push buttons  > 2 seconds. 	<ul style="list-style-type: none"> Double-pulse the remote line.  	<ul style="list-style-type: none"> 8-Segment display turns OFF. Sensor is in SETUP mode.
Select LO/DO and Delay Settings (see Figure 4)	<ul style="list-style-type: none"> Release push buttons.  	<ul style="list-style-type: none"> Wait > 8 seconds. 	<ul style="list-style-type: none"> Sensor is ready to select a new setting combination.
	<ul style="list-style-type: none"> Click Static (-) or Dynamic (+) push button to toggle between choices: Dynamic (+) — increment Static (-) — decrement 	<ul style="list-style-type: none"> Enter sequential pulses to toggle between choices: Single-pulse — increment Double-pulse — decrement 	<ul style="list-style-type: none"> Sensor steps between LO/DO and Delay setting combinations, as shown in Figure 4.
LO/DO Setting Shortcut	<ul style="list-style-type: none"> Not available using push buttons. 	<ul style="list-style-type: none"> From RUN mode, three-pulse the remote line.  	<ul style="list-style-type: none"> Sensor toggles between LO/DO settings on-the-fly, and continues in RUN mode.
Enter Sensing Beam Color Select Mode (from SETUP Mode)	<ul style="list-style-type: none"> From SETUP mode, press and hold Dynamic (+) push button > 2 seconds.  	<ul style="list-style-type: none"> From SETUP mode, four-pulse the remote line.  	<ul style="list-style-type: none"> Sensor displays currently selected sensing beam color combinations, as shown in Figure 5. Visible sensing beam also provides indication of enabled sensing beam color(s).
Enable/Disable Sensing Beam Colors (see Figure 5)	<ul style="list-style-type: none"> Click Static (-) or Dynamic (+) push button to toggle between choices: Dynamic (+) — increment Static (-) — decrement 	<ul style="list-style-type: none"> Enter sequential pulses to toggle between choices: Single-click — increment Double-click — decrement 	<ul style="list-style-type: none"> Sensor steps between possible sensing beam color combinations, as shown in Figure 5.* Visible sensing beam also provides indication of enabled sensing beam color(s).
Return to SETUP/RUN Mode	<ul style="list-style-type: none"> Press and hold Static (-) push button > 2 seconds to return to SETUP mode.  	<ul style="list-style-type: none"> Four-pulse the remote line to return to SETUP mode.  	<ul style="list-style-type: none"> Sensor returns to RUN mode with new settings. These steps will return to RUN mode from both SETUP modes.
	<ul style="list-style-type: none"> Then press and hold both push buttons > 2 seconds to return to RUN mode.  	<ul style="list-style-type: none"> Hold the remote line low > 2 seconds to return to RUN mode.  	
	<ul style="list-style-type: none"> Or wait > 60 seconds. 	<ul style="list-style-type: none"> Or wait > 60 seconds. 	

*If the new color setting has only one sensing beam color enabled, the sensor will switch to that color for sensing.

If the new color setting has multiple sensing beam colors enabled, the sensor will use the color that was active prior to configuration; following the next TEACH procedure, it will select the enabled sensing beam color that has the greatest contrast.

R58 Expert™ Registration Mark Sensors

Push Button Enable/Disable (Lockout)

In addition to its configuration function, the remote input may be used to disable the push buttons for security. Disabling the push buttons prevents unauthorized adjustment of the configuration settings. Connect the gray wire of the sensor as described on page 3, and four-pulse to either enable or disable the push buttons ($0.04 \text{ sec.} \leq "T" \leq 0.8 \text{ sec.}$):



NOTE: Push buttons can be disabled/enabled from the remote line only.

Installation Notes

The R58E includes a total of eight size M5 threaded holes used for mounting (see dimension drawing on page 11). These threaded holes are positioned to match the mounting hole patterns common to other registration mark sensors. The R58E includes four M5 x 0.8 x 6 mm stainless steel cap screws and a hex key wrench.

The R58E focus is 10 mm (0.39") from the lens surface. The R58E must be mounted within 3 mm (0.12") of this distance from the surface of the material for reliable sensing (Figure 6). Consider the following when mounting the R58E:

- Whenever possible, it is a good idea to sense a web material at a location where it passes over a tension bar or roller, to minimize the adverse effects of web "flutter" or sag (Figure 7).
- When sensing a registration mark on a reflective (shiny) material, mount the R58E at an angle which places the lens centerline at approximately 15° off perpendicular to the material's surface (Figure 8). This "skew angle" will minimize strong direct reflections (which tend to overwhelm the sensor), and allow the sensor to discern the relatively small optical contrast offered by differences in colors.
- Clear materials are poor reflectors of light. When sensing a mark printed on a clear material (e.g., a clear poly web), position a reflective surface directly behind the clear material to return light to the R58E. The printed mark, regardless of its color, then becomes the dark condition, as it blocks the light from reaching the reflective surface. Most clear materials are also shiny; it is important to include a 15° skew angle when sensing clear materials (Figure 8).

Lens Location

The lens may be installed at either of two lens ports (see Figure 6). The lens and the lens port cap are both threaded and may be exchanged by hand; no tools are required. The lens and cap both include an o-ring seal.

NOTE: The lens port cap must be installed on the unused port for reliable operation. Fully seat the lens cap to ensure a liquid-tight seal.

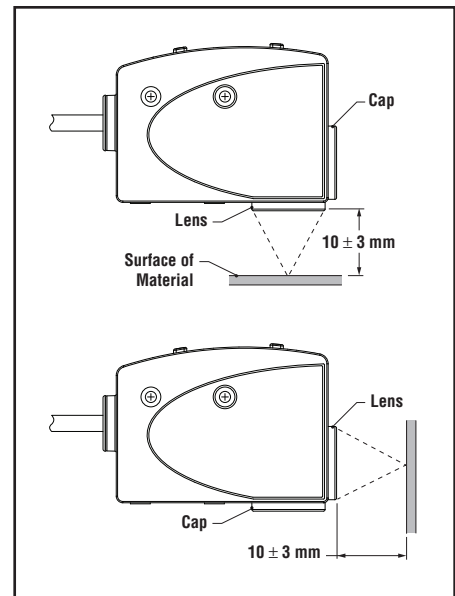

Figure 6. R58E lens positions

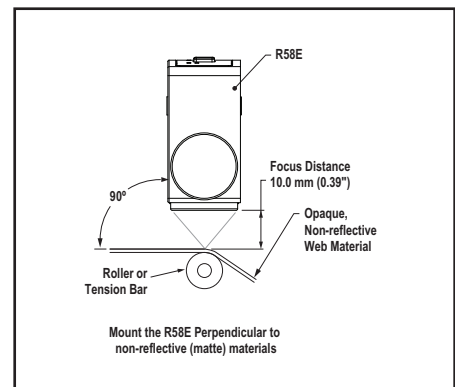

Figure 7. Mounting for sensing opaque non-reflective materials

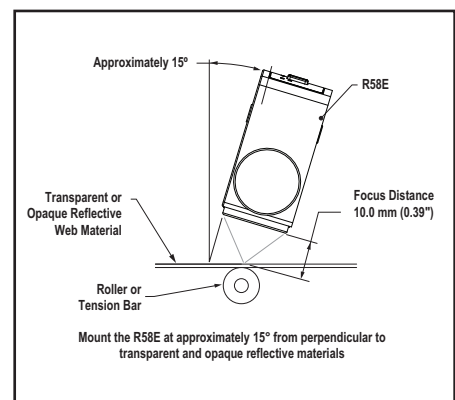
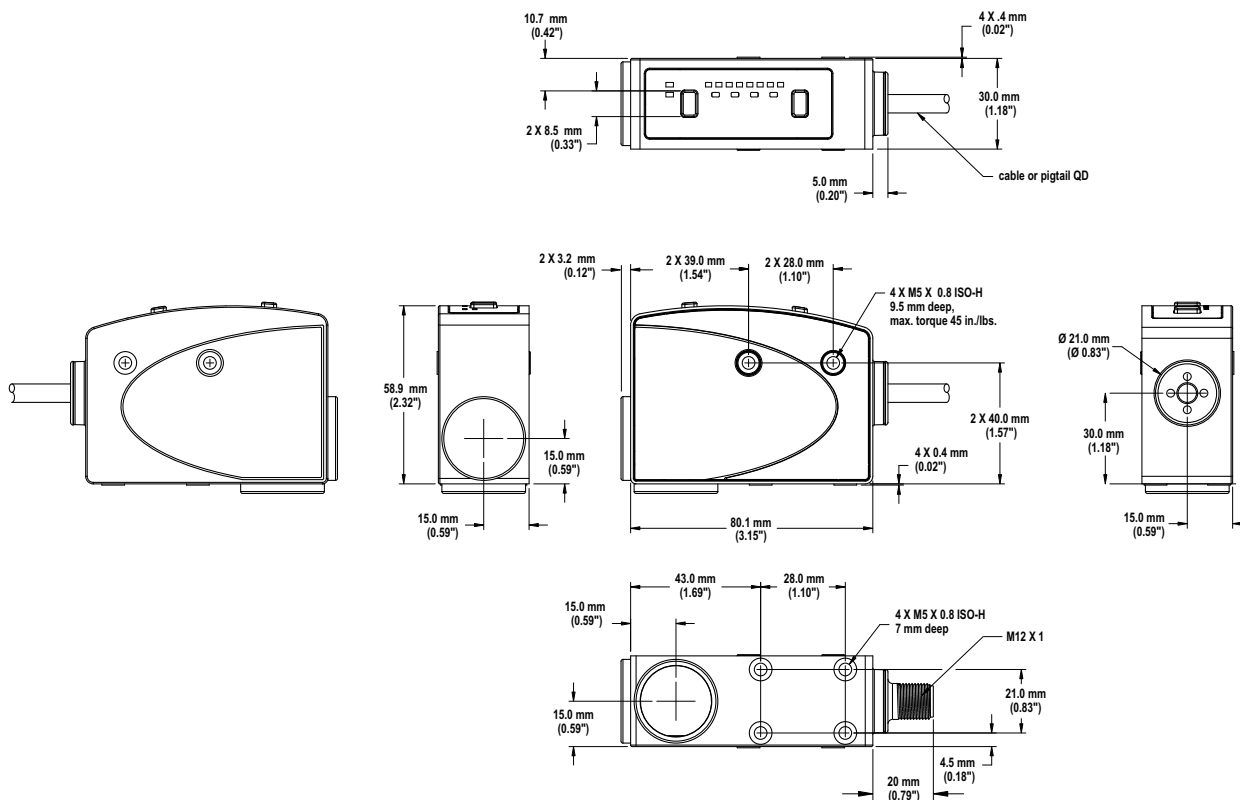

Figure 8. Mounting for sensing opaque reflective and transparent materials

R58 Expert™ Registration Mark Sensors

Dimensions



Hookups

Cabled Models

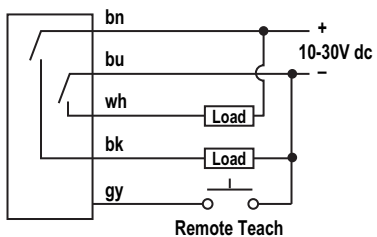

Quick-Disconnect Models

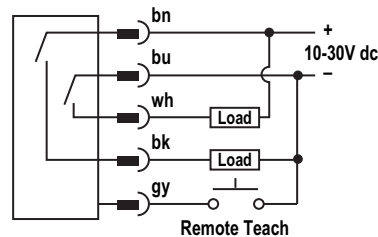

Accessories

Quick-Disconnect Cordsets

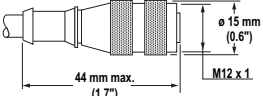
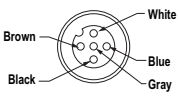
Style	Model	Length	Dimensions	Pinout
5-pin Euro-style straight, with shield	MQDEC2-506 MQDEC2-515 MQDEC2-530	2 m (6.5') 5 m (15') 9 m (30')		

R58 Expert™ Registration Mark Sensors

Accessory Mounting Brackets

SMB55A	<ul style="list-style-type: none"> • 15° offset bracket • 12-gauge stainless steel 	SMB55F	<ul style="list-style-type: none"> • Flat-mount bracket • 12-gauge stainless steel

Replacement Lens

Model	Description
UC-R55	Replacement lens for R58E 

R58 Expert™ Registration Mark Sensors



P/N 122928 rev. C

WARRANTY: Banner Engineering Corp. warrants its products to be free from defects for one year. Banner Engineering Corp. will repair or replace, free of charge, any product of its manufacture found to be defective at the time it is returned to the factory during the warranty period. This warranty does not cover damage or liability for the improper application of Banner products. This warranty is in lieu of any other warranty either expressed or implied.